



Los Alamos National Laboratory Support for Domestic ^{99}Mo Production

Gregory E. Dale

2017 ^{99}Mo Topical Meeting
Montreal, Quebec, Canada
September 13, 2017



LANL Support for Domestic ^{99}Mo Production

- As part of the NNSA Material Management and Minimization (M^3) Program, LANL is supporting:
 - Shine Medical Technologies with the production of fission product ^{99}Mo from a DT accelerator driven subcritical uranium salt solution.
 - NorthStar Medical Radioisotopes with the electron accelerator production of ^{99}Mo from $^{100}\text{Mo}(\gamma, n)^{99}\text{Mo}$.

SHINE Medical Technologies Production Overview

SHINE Medical Technologies will produce fission product ^{99}Mo in a subcritical accelerator driven low enriched uranium salt solution.

In FY17 LANL has been supporting SHINE in the development of coupled thermal hydraulics and neutron transport modeling.

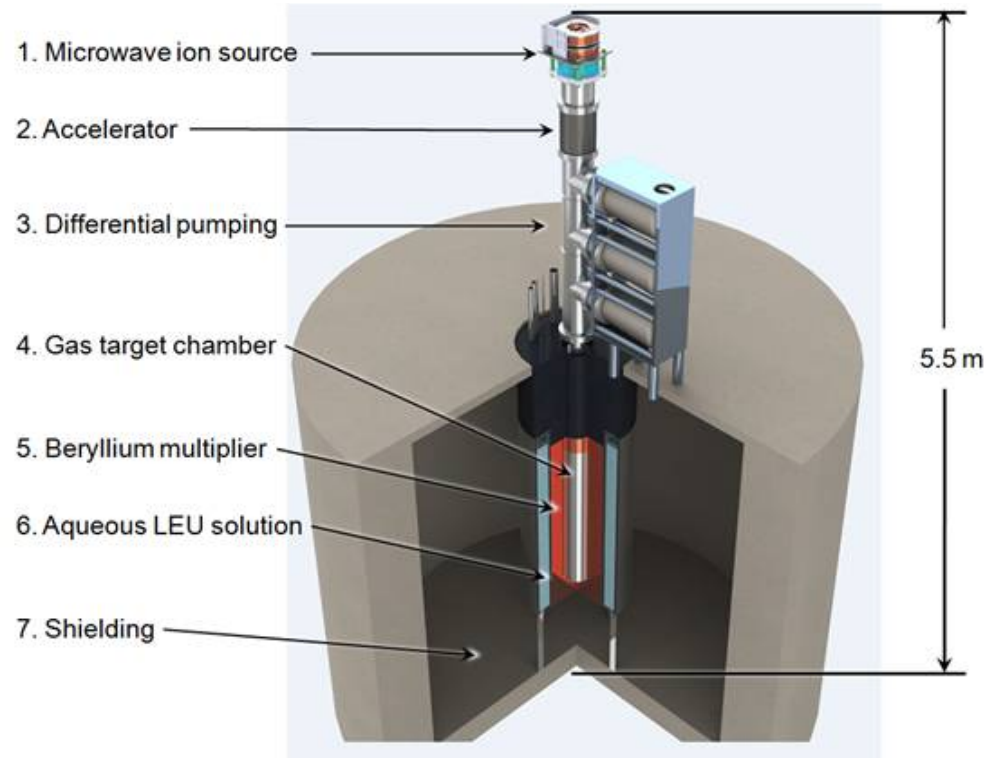

Coupled Neutron Transport/ CFD Modeling

D-T neutron production

MCNP neutron transport for fission rate (power and gas generation profiles)

CFD Model for flow velocity, temperature (density) and void profile

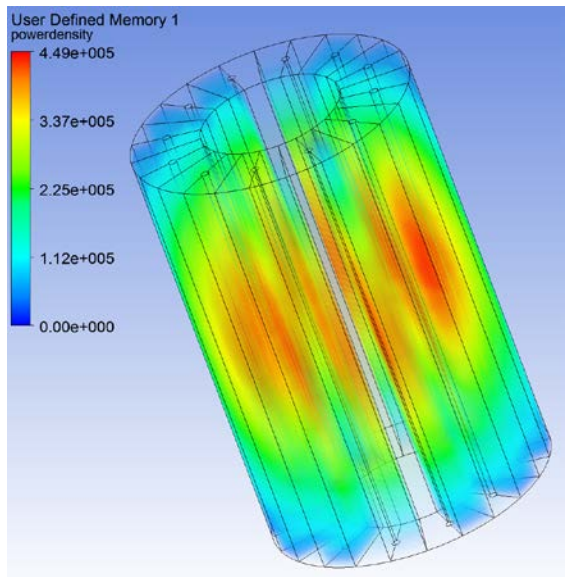
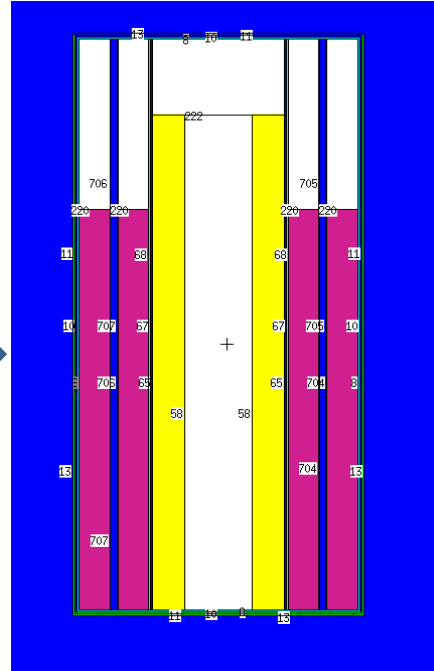
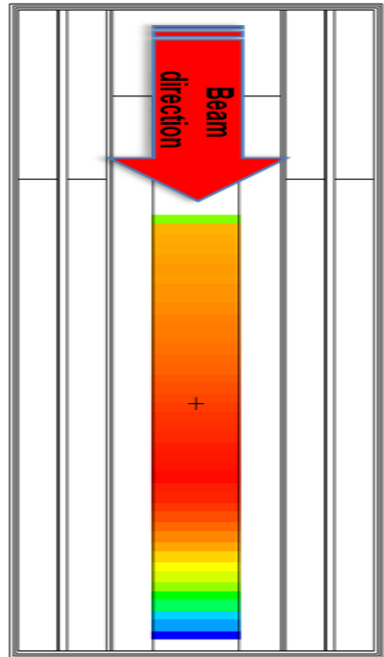

Coupled Modeling Iteration Loop

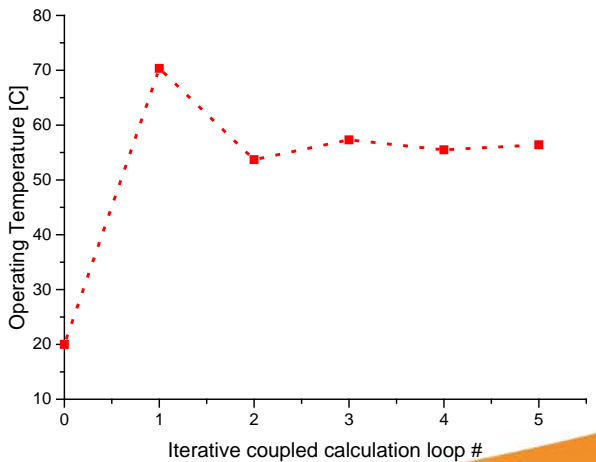
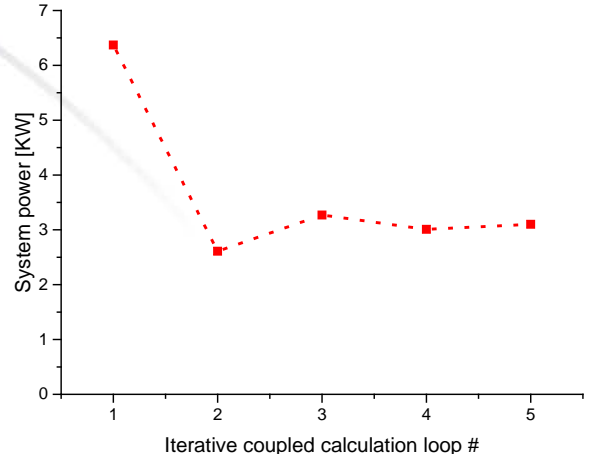
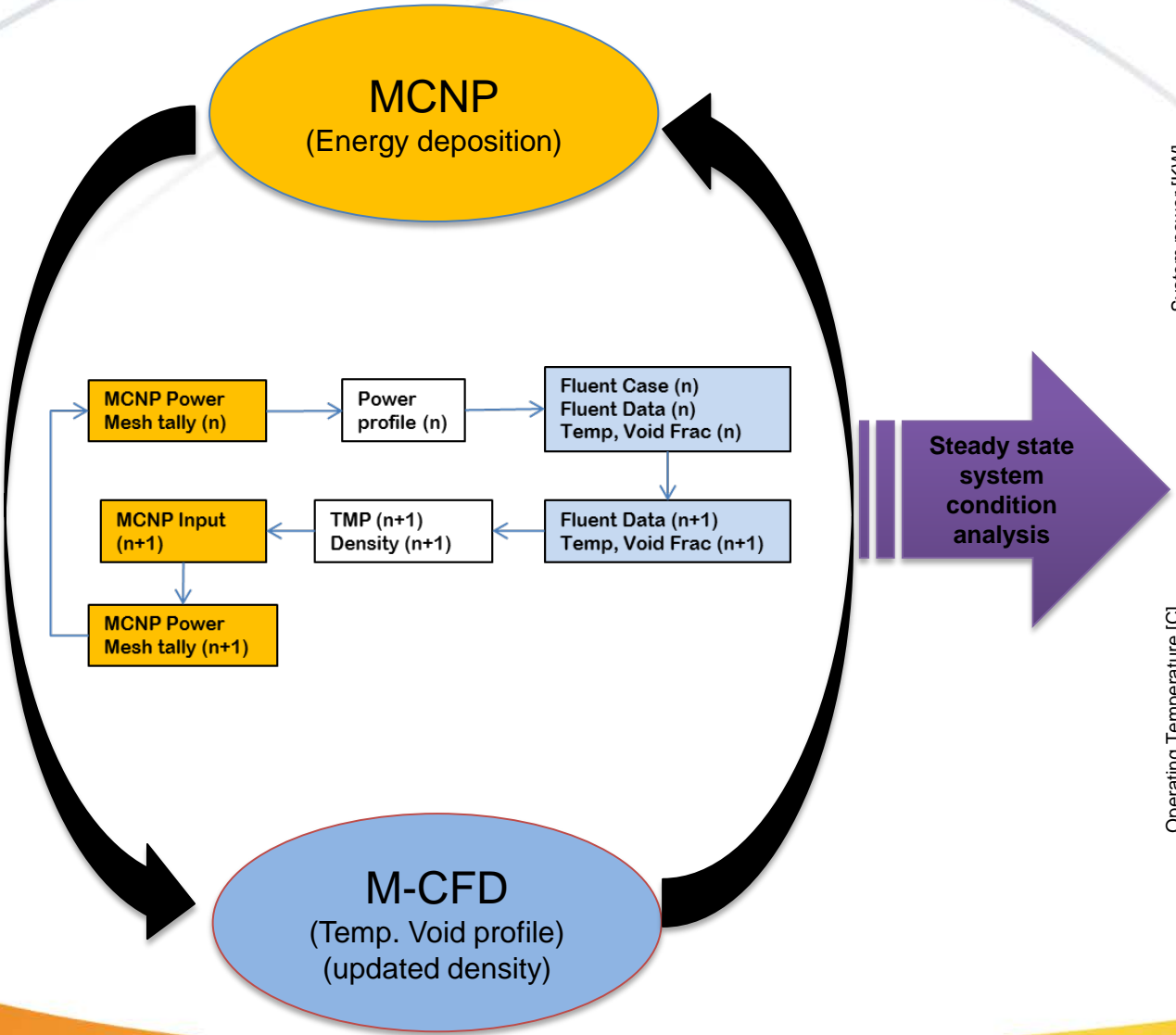

Coupled Modeling Results

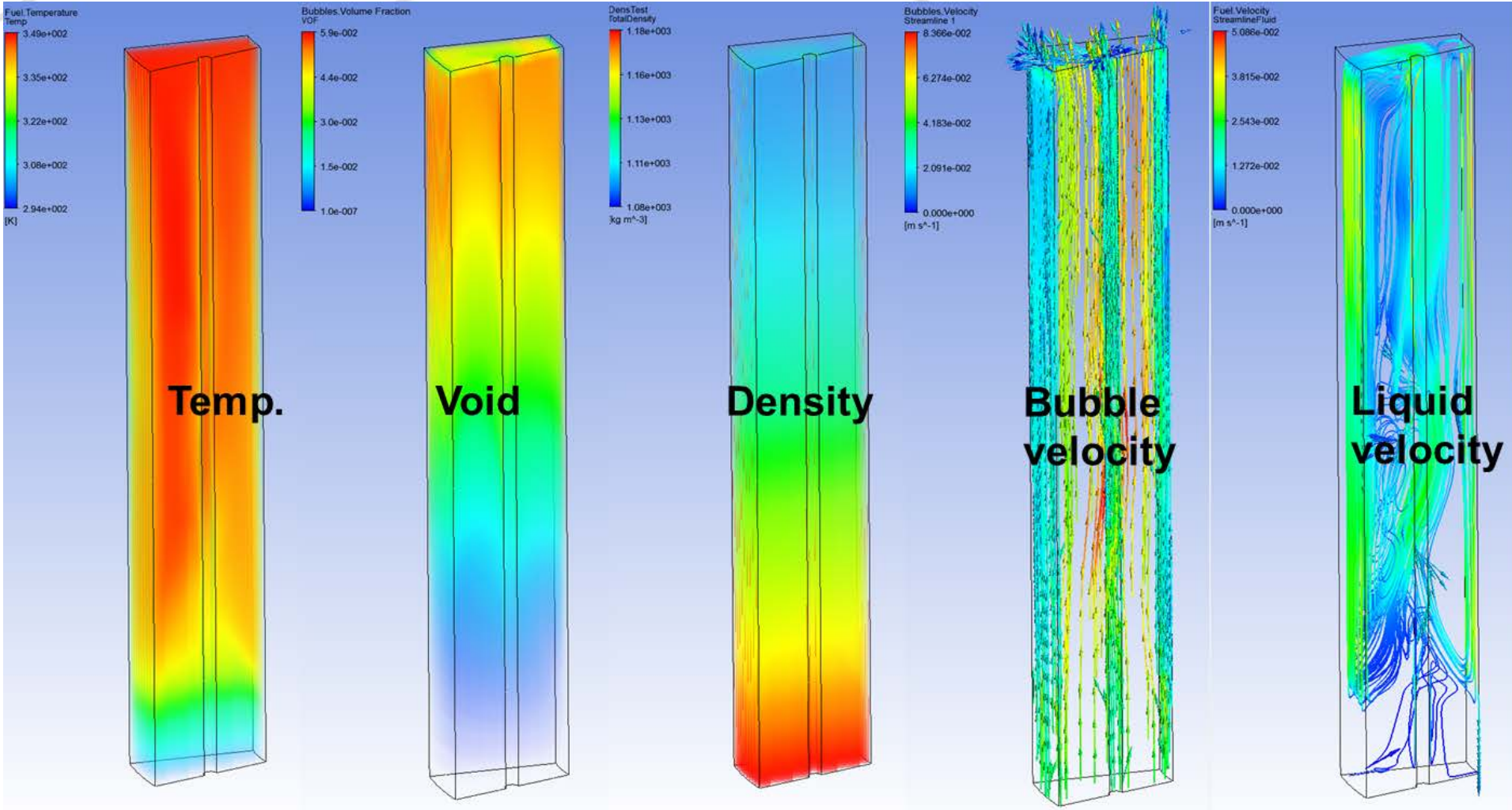

Supo “Super-Power” Thermal Modeling

- **45 kW water boiler reactor**
 - Uranyl-nitrate solution
 - Operated from 1951 to 1974
 - Used for neutron research
 - Contained water-cooled spiral coils to maintain desired operating temperatures
- **Multiphase steady state CFD simulations using ANSYS Fluent**
 - 2-D axisymmetric model
 - Modeled natural convective heat transfer of solution
 - Assumed laminar flow
 - Gaussian power deposition profile
 - Rising bubbles enhance fluid motion and heat transfer

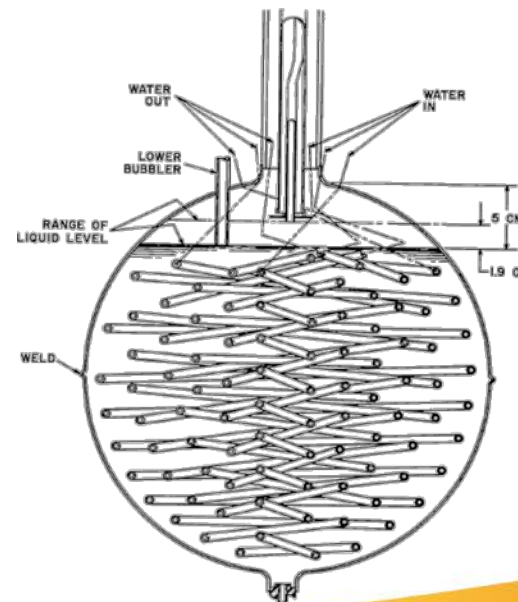
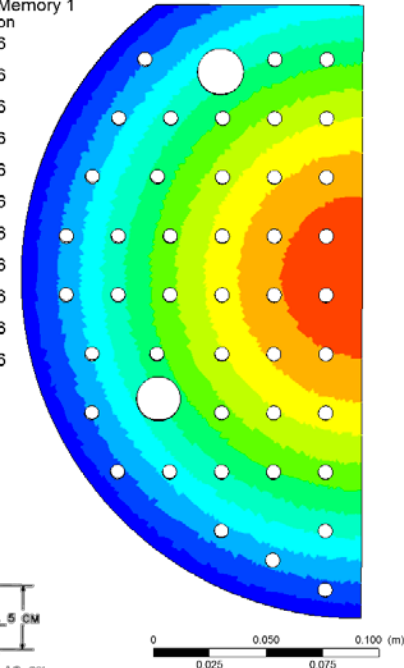
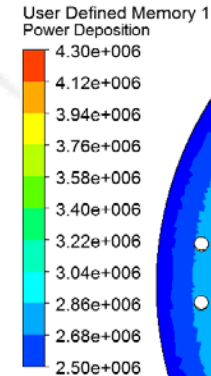
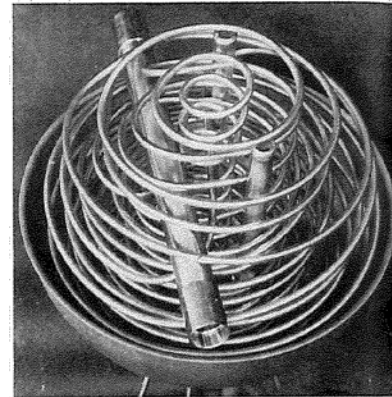

SUPO Modeling Results

- **Simulation vs. past experiment data**
- **Heat Transfer Coefficient (HTC)**
 - Under predicted HTC of highest power by 40%
 - Over predicted HTC of lowest power by 479%
- **Avg. Solution Temperature**
 - Over predicted temp. at highest power by 8.6°C
 - Under predicted temp. at lowest power by 25.4°C
- **Future Work**
 - Assume turbulent flow at high powers
 - Assume laminar flow at low powers
 - Remove radiolytic bubbles at low powers

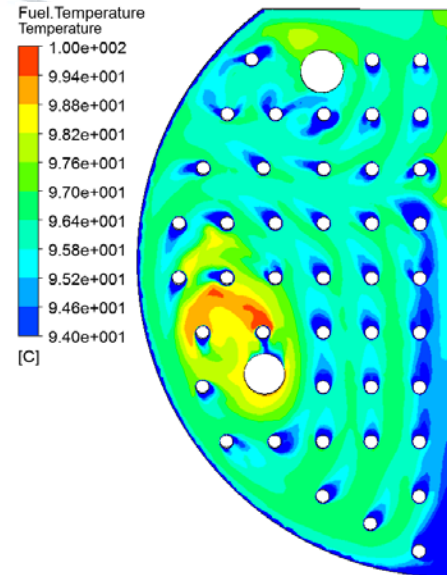

Steady state temperature profile of 3.05 kW/L (40 kW) reactor

Max temp. = 96.18°C

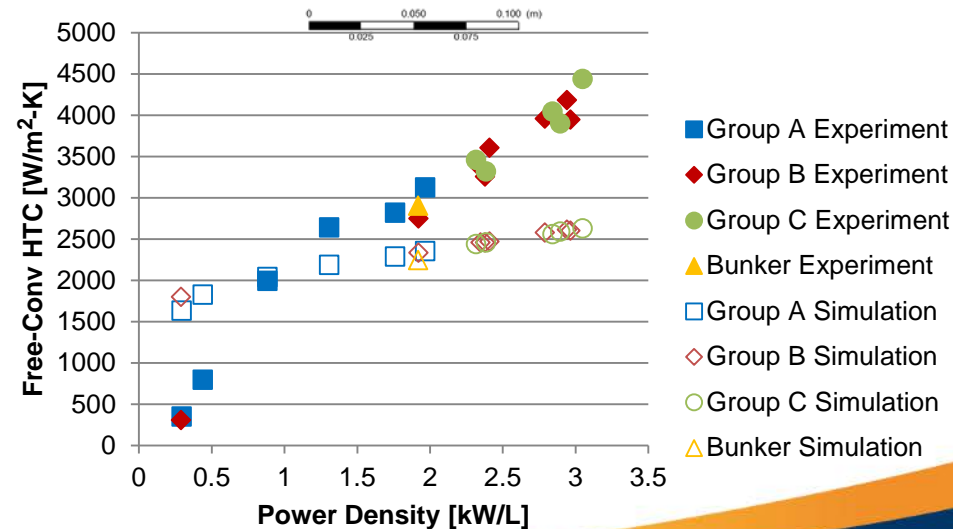

NorthStar Electron Accelerator Production

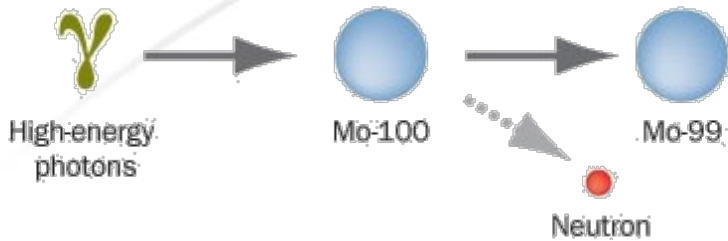

- The NorthStar process uses an electron accelerator to create a high flux of bremsstrahlung photons in enriched ^{100}Mo targets to create ^{99}Mo through the photonuclear reaction $^{100}\text{Mo}(\gamma, n)^{99}\text{Mo}$.
 - Reaction threshold is 9 MeV.
 - Peak cross section is 150 mb at 14.5 MeV.
- We are exploring electron beams in the 35-42 MeV range.

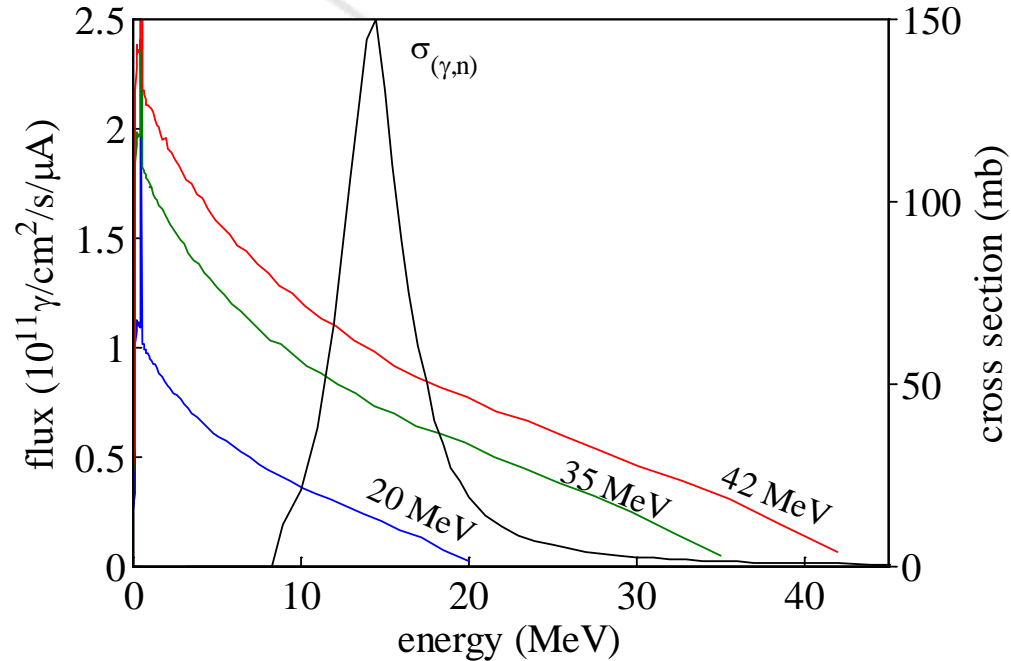

Average bremsstrahlung photon spectra produced with 20, 35, and 42 MeV electron beams in a Mo target compared to the photonuclear cross section of ^{100}Mo .

29 mm Target System for Testing at ANL

A larger diameter target will be needed for production at the beam powers being considered.

The new target design also varies the target disk thickness, which creates a more even power profile through the length of the target.

Peak Window and Target Disk Temperature: 35 MeV @ 285 psi Inlet
($\dot{m} = 0.116 \text{ kg/s}$)

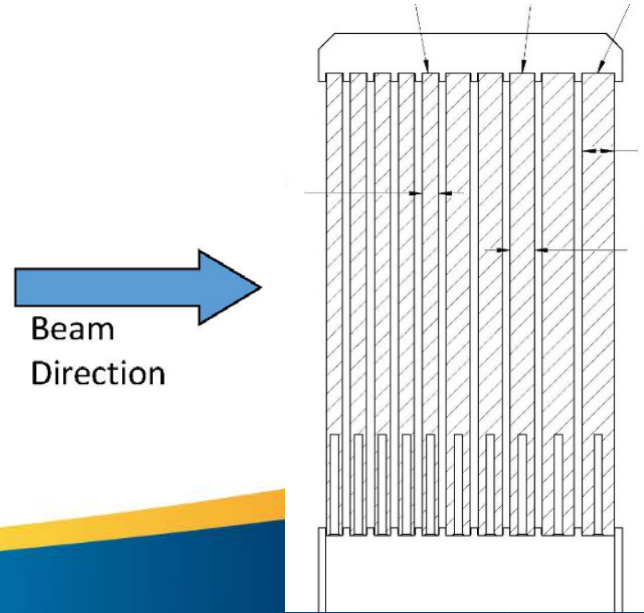
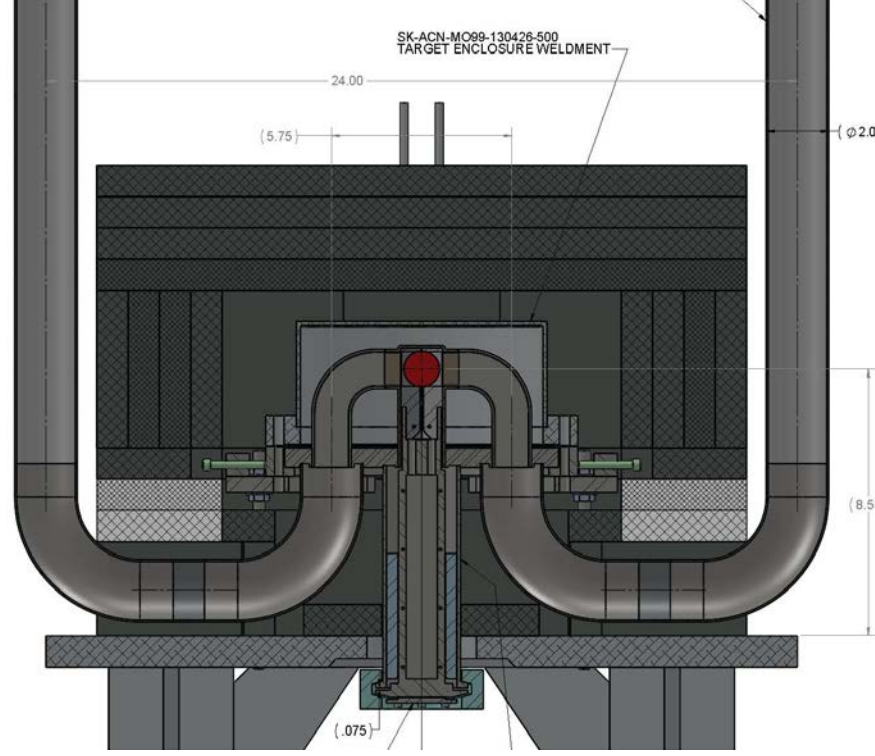
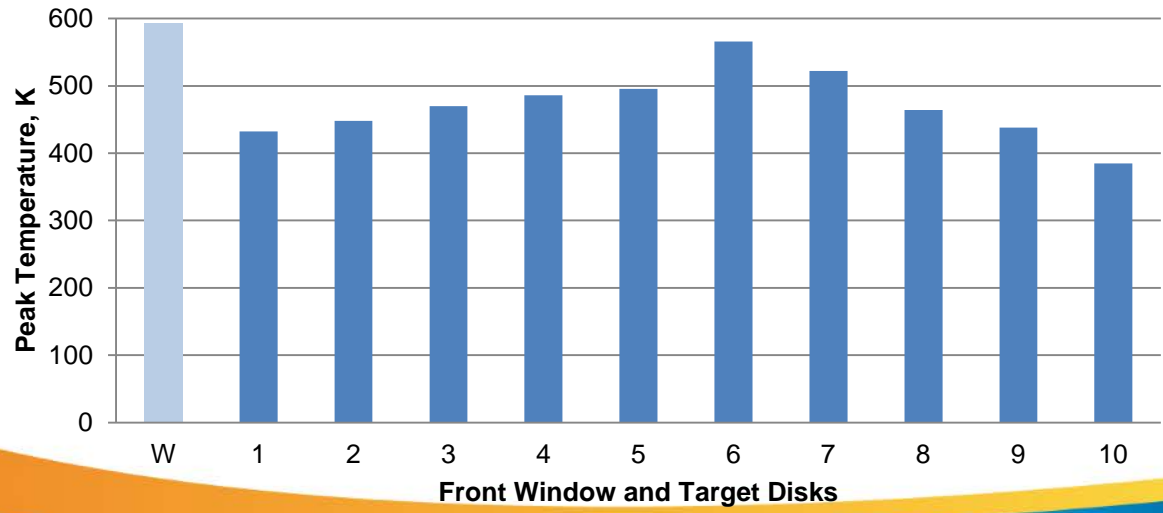

LANL 29 mm Diameter Mo Target for Testing at ANL

Target Side View

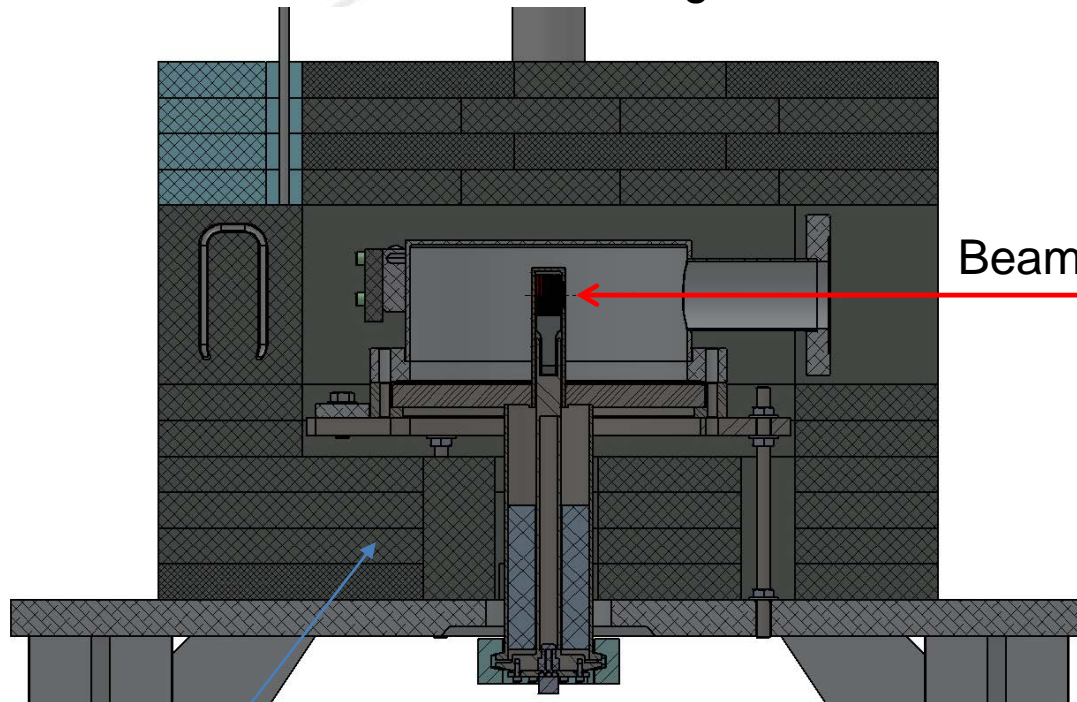

Lead Shielding

Beam

Target window

Helium cooling lines

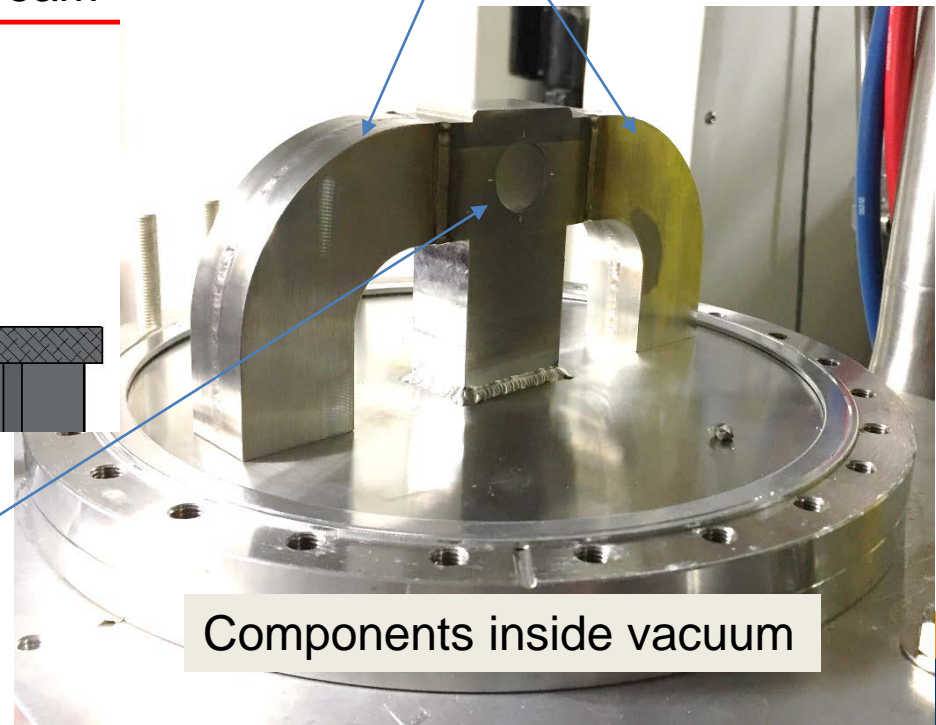

Components inside vacuum

29 mm Target Installed at ANL

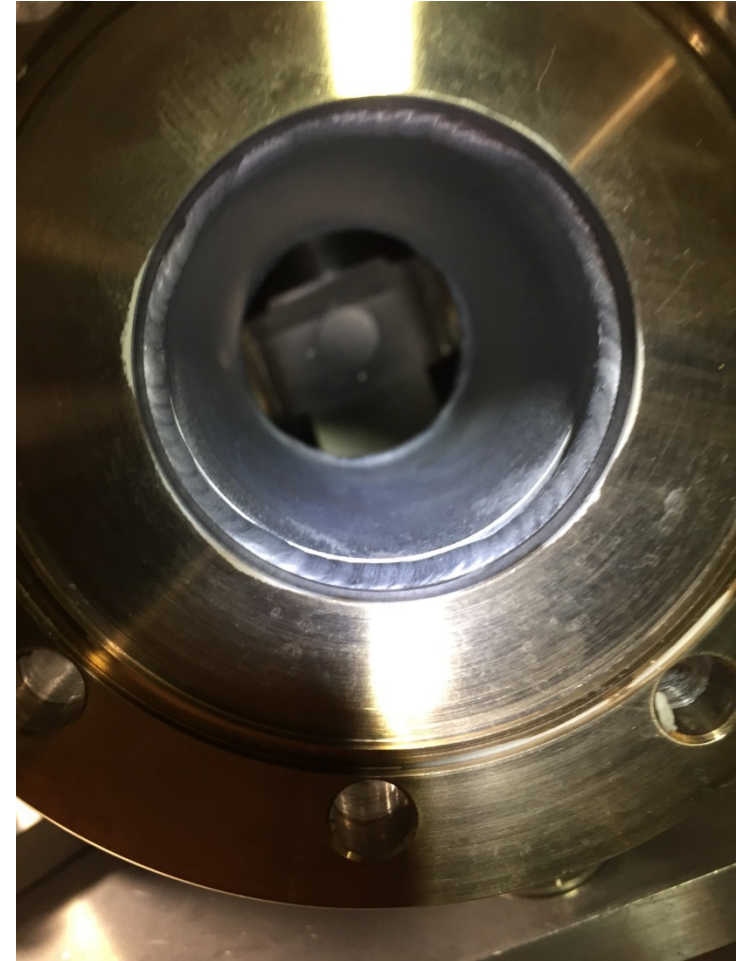

29 mm Target

29 mm Targets before irradiation

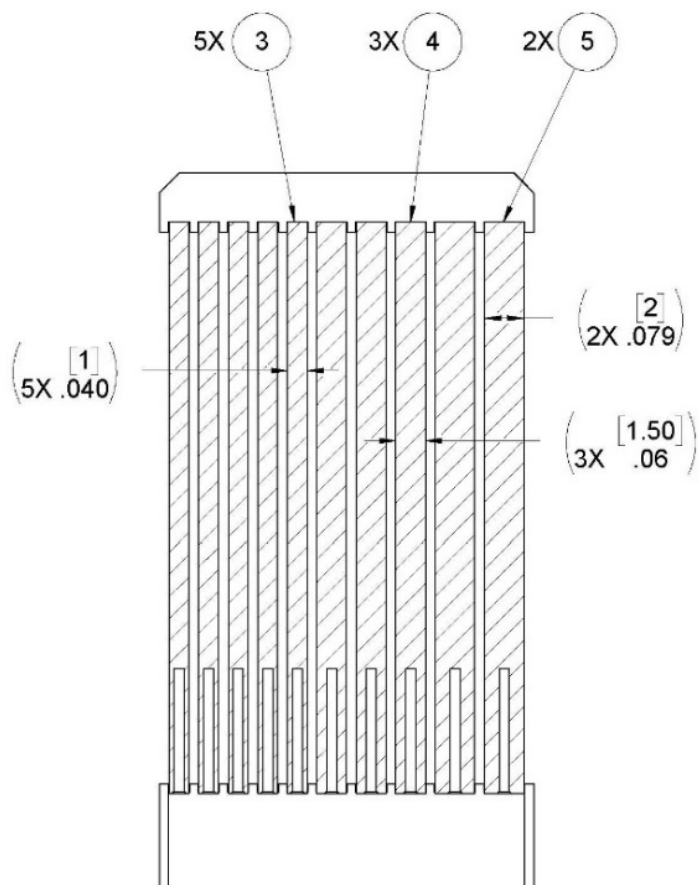

Coolant View



Beam View

Target consisting of 29 mm diameter disks with 0.5 mm cooling gaps. Five disks are 1 mm thick, three are 1.5 mm thick, and two are 2 mm thick.

29 mm Target with Lead Shielding

Thermal test performed
on August 18.

Results currently being
analyzed.



Resistively Heated Target Experiments

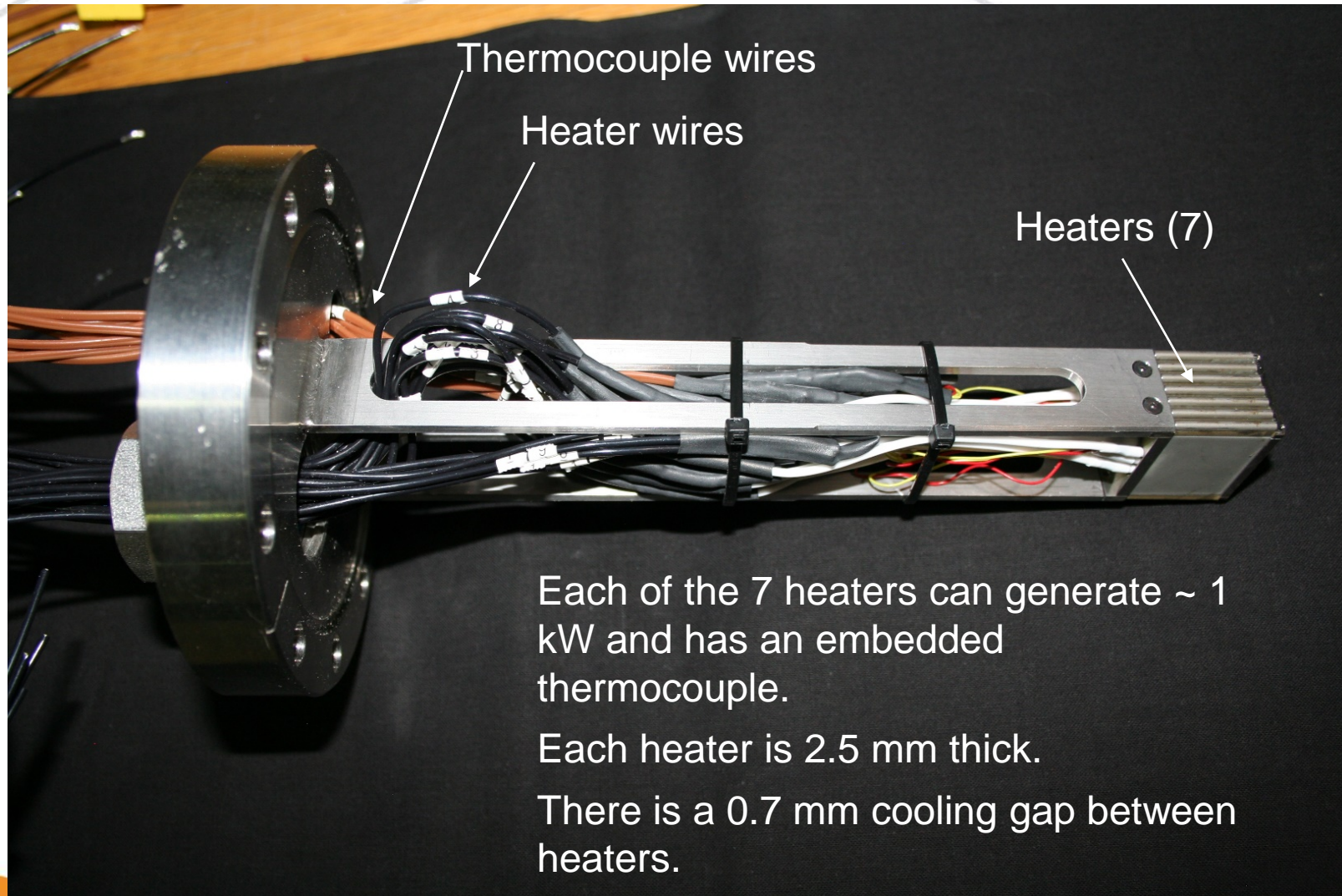

Resistively Heated Target Testing on the Helium Flow Loop

- The resistively heated target will be installed for testing on the prototype helium flow loop at LANL.
- We are also continuing our long duration flow tests on this system, having recently started our third 7-week continuous run test this FY.

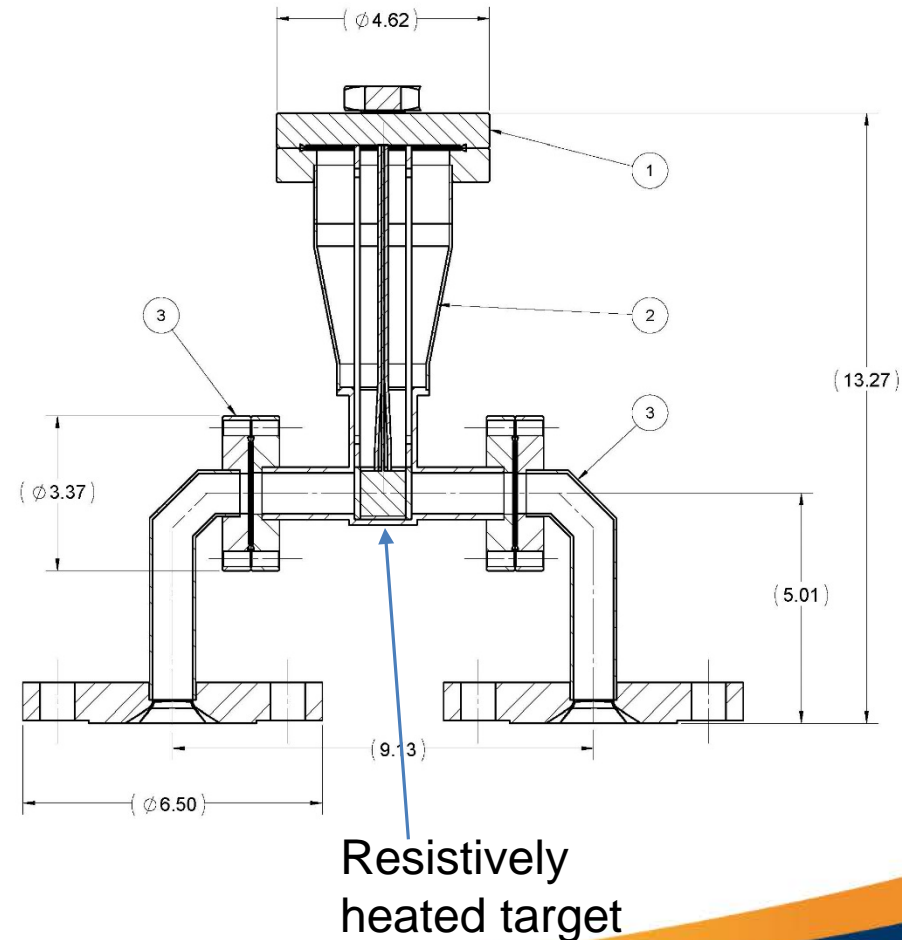

OTR/IR Coupon Testing

- Test the performance of coated and uncoated Inconel mock windows in beam with our Optical Transition Radiation (OTR) and Infrared (IR) diagnostics.



Uncoated Inconel
mock window



Inconel mock
window coated
with very high
temperature
(VHT) thermal
paint.

Mock Window Testing Results at 35 MeV

Uncoated

Coated

OTR

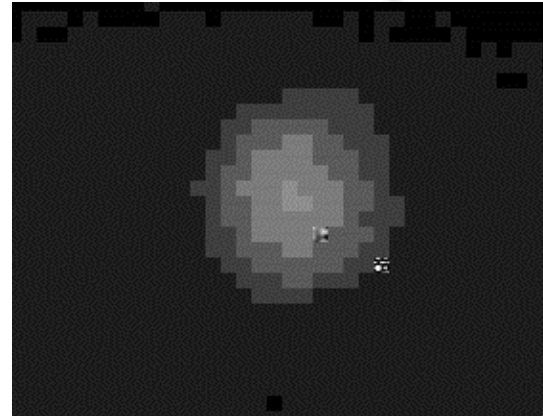
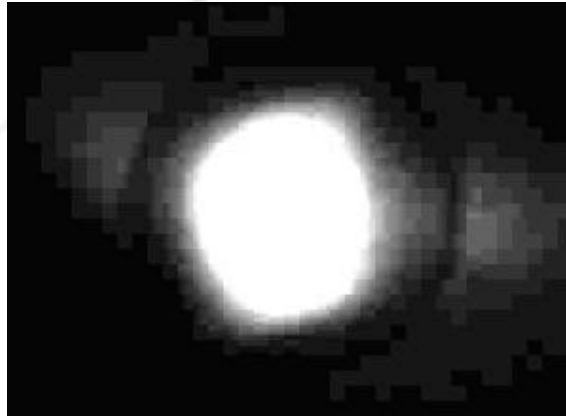

Remaining work:

- In-situ IR Calibration
- Longevity studies on the coating.

IR

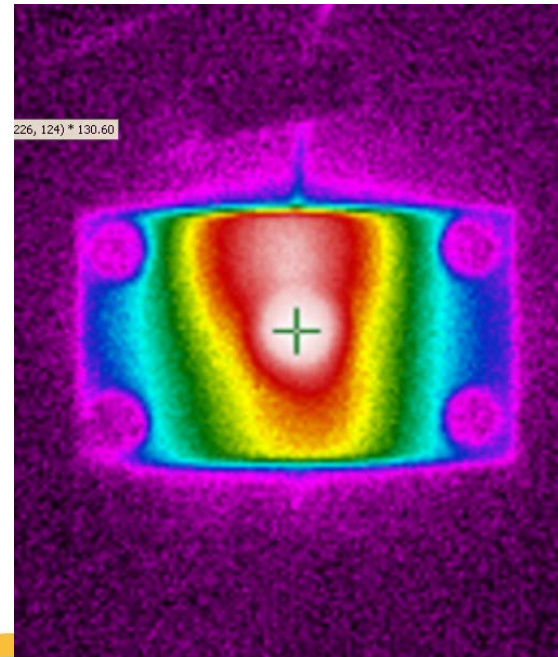
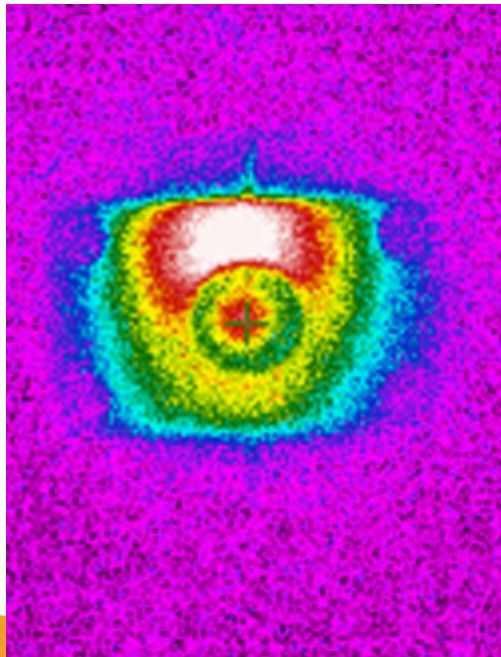

Summary

- LANL is partnering closely with NNSA and the other National Laboratories to help develop the commercial domestic production of ^{99}Mo without the use of HEU.
- Under the M^3 ^{99}Mo Program, we are currently supporting SHINE Medical Technologies and NorthStar Medical Radioisotopes.
- Leveraging the unique capabilities of the National Laboratories to facilitate the domestic production of ^{99}Mo .